

**Xcomfort CSAP-01/0X**

Montageanweisung  
 Assembly instructions  
 Instructions de montage  
 Montážní návod  
 Montagevejledning  
 Instrucciones de montaje  
 Szerelési utasítás  
 Istruzioni di montaggio  
 Montasje anvisning  
 Montage instructie  
 Instruções de montagem  
 Instrukcja montażu  
 Montageanvisning  
 Asennusohjeet  
 Montaj talimatı  
 Instrukciuni de montaj

Инструкция по монтажу  
 οδηγία συναρμολόγησης  
 装配说明  
 تعليمات التركيب





Lebensgefahr  
 Danger  
 Danger de mort  
 Nebezpečí  
 Fare  
 Peligro  
 Életveszély  
 Pericolo di morte  
 Fare  
 Levensgevaar  
 Perigo  
 Niebezpieczeństwo  
 Varning  
 Vaara  
 Hayati Tehlike  
 Pericol  
 Опасность  
 κίνδυνος θανάτου  
 危險  
 خطر على الحياة

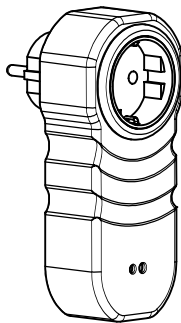

Montage nur durch Elektrofachkräfte  
 Installation by electricians only  
 Montage uniquement par un électricien  
 Montáž pouze osobami s elektrotechnickou kvalifikací  
 Må kun installeres af en aut. el-installatør  
 Debe ser instalado por un profesional eléctrico  
 Csak szakképzett személy szerelheti  
 Montaggio esclusivamente ad opera di personale specializzato  
 Må monteres av autorisert installatør Gr.L  
 Montage alleen door elektromonteurs  
 Deve ser instalado por um profissional  
 Montaz tylko przez uprawnionych instalatorów  
 Får endast utföras av behörig elektriker  
 Asennus vain sähköasentajan toimesta  
 Sadece uzman kişiler monte edebilir  
 Instalare numai de către electricieni  
 Монтаж может производить только элекрик  
 οδηγία συναρμολόγησης  
 仅允许电工安装  
 التركيب فقط من قبل عمال كهرباء اختصاصيين



	T=-25°C - +70°C
	T=-5°C - +45°C

IP20

868,3 MHz

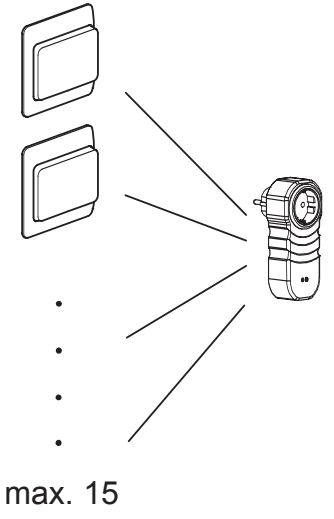
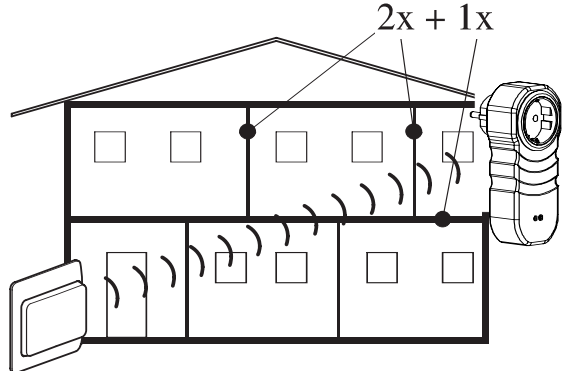
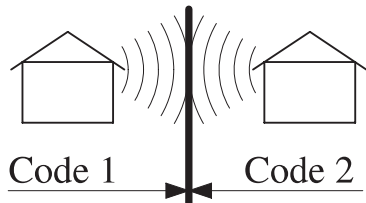
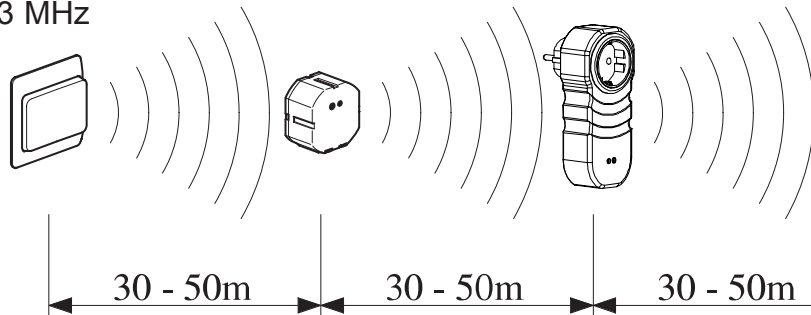

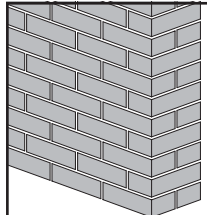
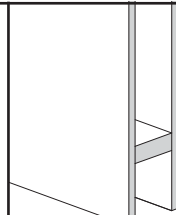
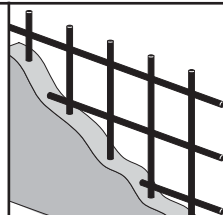
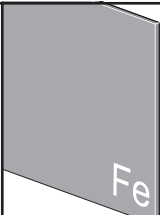
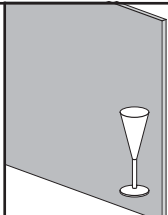
					
	~ 60-90%	~ 80-95%	~ 20-60%	~ 0-10%	~ 70-90%

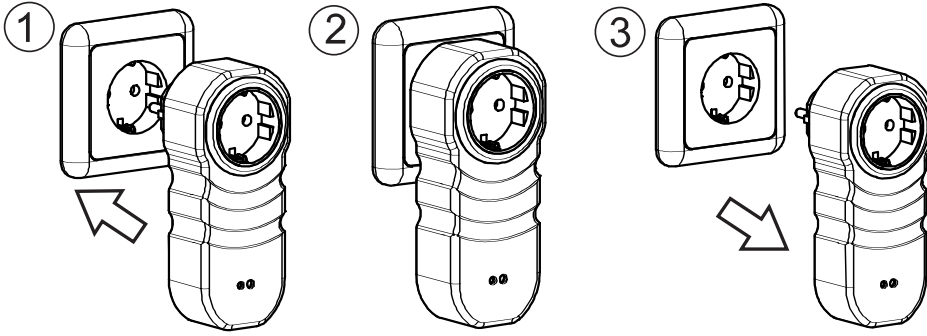

CSAP-01-01 Schuko / German Standard  
 CSAP-01-02 French Standard  
 CSAP-01-03 British Standard

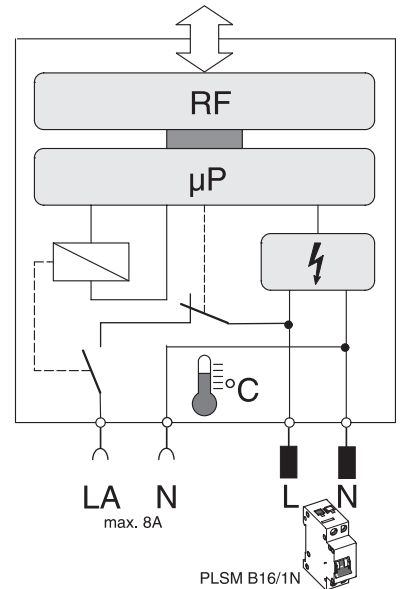

Moeller Gebäudeautomation KG

### Konformitätsbescheinigung Certification of Conformity

Wir Moeller Gebäudeautomation KG

We (Name des Anbieters / supplier's name)  
Eugenia 1  
A-3943 Schrems  
 (Anschrift / adress)

bescheinigen hiermit, daß das Produkt  
 hereby certify that the product

**Moeller - Zwischenstecker Schaltaktor**  
 Moeller - Plug in adapter - switching

Type: CSAP-...

type-key according actual catalog

(Bezeichnung, Type oder Modell, Los-, Chargen- oder Serien-Nr., möglichst Herkunft und Stückzahl /  
 name, type or model, batch or serial number, possible sources and number of items)

auf das sich diese Bescheinigung bezieht, mit der/den folgenden  
 Norm(en) oder normativen Dokument(en) übereinstimmt.

to which this certification relates is in conformity with the following standard(s)  
 or other normative document(s).

**EN301489-3 V1.4.1, EN50090-2-2/96, EN60669-2-1/00 + A2/01, IEC60884-1/02, EN300220-3 V1.1.1, EN50371/02**

(Titel und/oder Nr. sowie Ausgabedatum der Norm(en) oder der anderen normativen Dokumente /  
 Titel and/or number and date of issue of the standard(s) or other normative document(s).)

Gemäß den Bestimmungen der Richtlinie(n)

Following the provisions of the Directive(s) falls zutreffend / if applicable

**Niederspannungsrichtlinie 73 / 23 / EWG**

Low Voltage Directive 73 / 23 / EWG

**EMV-Richtlinie 89 / 336 / EWG**

EMC Directive 89 / 336 / EWG

**Radio- und Telekommunikationsendgeräte 99 / 05 / EWG**

Radio Equipment and Telecommunications Terminal Equipment 99 / 05 / EW

geprüft von / tested by **TÜV Österreich, Notified Body 0408**  
**A-1230 Wien, Deutschstrasse 10**  
**CTI-Vienna**  
**A-1210 Wien, Einzingerasse 4**

**CE0408**

Eine rechtsverbindliche Konformitätserklärung gemäß EN 45014 liegt vor.  
 The legally declaration of conformity according EN 45014 is available.

Schrems, 09.12.2004

*(Signature)*  
 G. Idinger

*(Signature)*  
 (Ing. F./Schroder)



(Ort, Datum der Ausstellung / place, date of issue)

(Name und Unterschrift / name and signature)





# MOELLER



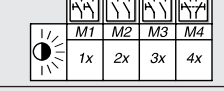

## RF - SYSTEM

### BASIC - MODE - CARD

www.moeller.at - info.aut@moeller.net

ma-rf-system.qxd/136211012

	CTAA-01/0X CTAA-02/0X
	CBEU-02/0X
	M1 M2 M3 M4 1x 2x 3x 4x
	CRCA-00/0X
	CHSZ-00/0X

	CSAU-01/0X CSAP-01/0X
	CJAU-01/0X
	CDAU-01/0X CDAP-01/0X
	0-10V OUT CAAE-01/0X

